

ENGLISH

Infinity XPLO-15 LED Strobe V1

Ordercode: 40280

Table of contents

Warning	3
Safety Instructions	4
Operating Determinations	5
Rigging	5
Connection with the mains.....	6
Return Procedure.....	7
Claims.....	7
Description of the device	8
Frontside.....	8
Backside	9
Installation	9
Set Up and Operation	9
Control Modes.....	10
One Infinity (Stand-alone).....	10
Multiple Infinities (Master/Slave control).....	10
Multiple Infinities (DMX Control)	11
Fixture Linking.....	12
Data Cabling.....	12
Control Panel.....	13
Control Mode	13
DMX Addressing.....	13
Menu Overview.....	14
Main Menu Options.....	16
1. Presets	17
1.1. Editing a preset	17
2. Chases	19
2.1. Editing a chase	19
2.2. Editing an effect	20
2.3. Adding a new step	21
2.4. Deleting a step.....	21
3. Settings.....	22
3.1. Security	22
3.2. General	23
3.3. Factory Default	25
3.4. DMX Mode.....	26
3.5. DMX Address Setting.....	26
3.6. Display	27
4. Fixture Lock	28
5. Password	28
6. Status.....	29
DMX Channels.....	30
1 channel (Single Channel)	30
3 channels (Three Channel)	30
4 channels (Four Channel)	30
6 channels (16-bit Control)	31
28 channels (Zone Mapping)	32
RDM Parameter IDs.....	34
XPLO-15 LED Strobe RDM Product Parameter IDs	34
XPLO-15 LED Strobe RDM UID	34
XPLO-15 LED Strobe RDM Parameter IDs.....	35
XPLO-15 LED Strobe RDM Manufacturer Status IDs	36
XPLO-15 LED Strobe RDM Manufacturer Specific PIDs for Root Device.....	37

Maintenance37

Troubleshooting38

 No Light38

 No Response to DMX.....38

Product Specifications40

Dimensions41

Notes42

Warning



**For your own safety, please read this user manual carefully
before your initial start-up!**



Unpacking Instructions

Immediately upon receiving this product, carefully unpack the carton and check the contents to ensure that all parts are present, and have been received in good condition. Notify the dealer immediately and retain packing material for inspection if any parts appear damaged from shipping or the carton itself shows signs of mishandling. Save the carton and all packing materials. In the event that a fixture must be returned to the factory, it is important that the fixture be returned in the original factory box and packing.

Your shipment includes:

- Infinity XPLO-15 LED Strobe
- Power cable Neutrik Powercon True1 to Schuko 1,5 m (90471)

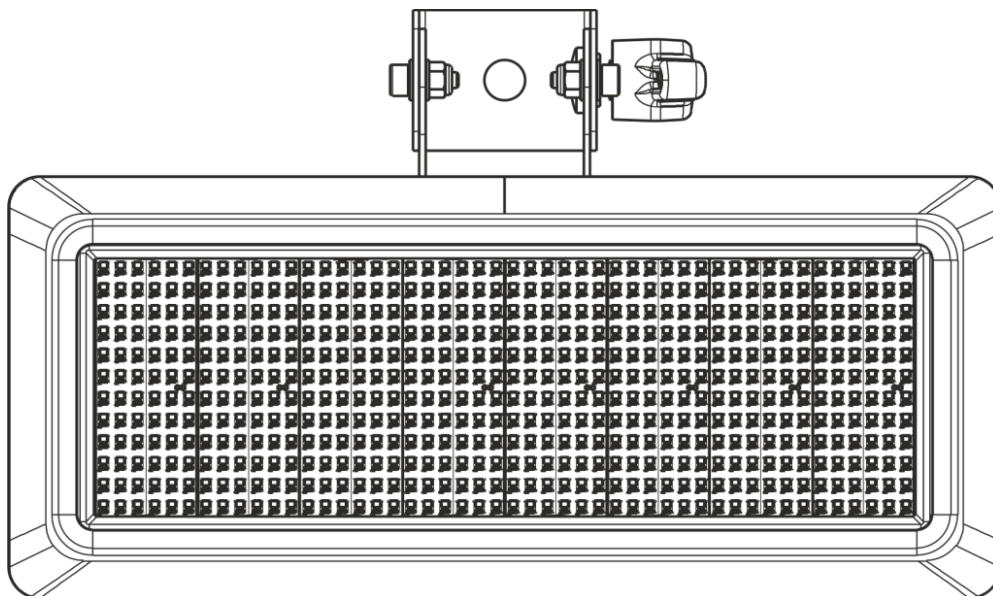

LED Expected Lifespan

LEDs gradually decline in brightness over time. HEAT is the dominant factor that leads to the acceleration of this decline. Packaged in clusters, LEDs exhibit higher operating temperatures than in ideal or singular optimum conditions. For this reason, when all color LEDs are used at their fullest intensity, life of the LEDs is significantly reduced. If improving life expectancy is of higher priority, place care in providing for lower operational temperatures. This may include climatic-environmental and the reduction of overall projection intensity.



CAUTION!
Keep this device away from rain and moisture!
Unplug mains lead before opening the housing!



Safety Instructions

Every person involved with the installation, operation and maintenance of this device has to:

- be qualified.
- follow the instructions of this manual.

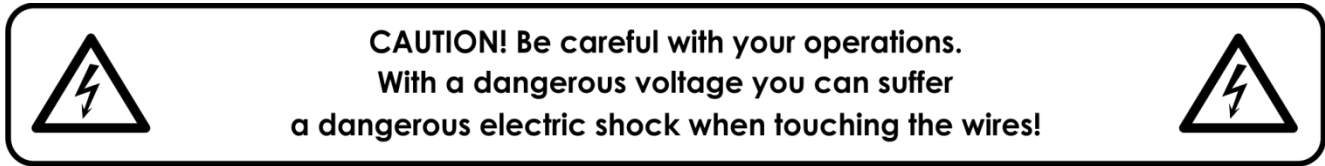

Before the initial start-up, please make sure that there is no damage caused by transportation. Should there be any, consult your dealer and do not use the device.

To maintain perfect condition and to ensure a safe operation, it is absolutely necessary for the user to follow the safety instructions and warning notes written in this manual.

Please consider that damages caused by manual modifications to the device are not subject to warranty.

This device contains no user-serviceable parts. Refer servicing to qualified technicians only.

IMPORTANT:

The manufacturer will not accept liability for any resulting damages caused by the non-observance of this manual or any unauthorized modification to the device.

- Never let the power cord come into contact with other cables! Handle the power cord and all connections with the mains with particular caution!
- Never remove warning or informative labels from the unit.
- Never use anything to cover the ground contact.
- Never lift the fixture by holding it at the projector-head, as the mechanics may be damaged. Always hold the fixture at the transport handles.
- Never place any material over the lens.
- Never look directly into the light source.
- Never leave any cables lying around.
- Do not connect this device to a dimmerpack.
- Do not switch the device on and off in short intervals, as this would reduce the device's life.
- Do not touch the device's housing bare-handed during its operation (housing becomes very hot). Allow the fixture to cool for at least 5 minutes before handling.
- Do not shake the device. Avoid brute force when installing or operating the device.
- Only use device indoor, avoid contact with water or other liquids.
- Only operate the fixture after having checked that the housing is firmly closed and all screws are tightly fastened.
- Only operate the device after having familiarized with its functions.
- Avoid flames and do not put close to flammable liquids or gases.
- Always keep case closed while operating.
- Always allow free air space of at least 50 cm around the unit for ventilation.
- Always disconnect power from the mains, when device is not used or before cleaning! Only handle the power cord by the plug. Never pull out the plug by tugging the power cord.
- Make sure that the device is not exposed to extreme heat, moisture or dust.
- Make sure that the available voltage is not higher than stated on the rear panel.
- Make sure that the power cord is never crimped or damaged. Check the device and the power cord from time to time.
- If the lens is obviously damaged, it has to be replaced. So that its functions are not impaired, due to cracks or deep scratches.
- If device is dropped or struck, disconnect mains power supply immediately. Have a qualified engineer inspect for safety before operating.

- If the device has been exposed to drastic temperature fluctuation (e.g. after transportation), do not switch it on immediately. The arising condensation water might damage your device. Leave the device switched off until it has reached room temperature.
- If your Infinity device fails to work properly, discontinue use immediately. Pack the unit securely (preferably in the original packing material), and return it to your Infinity dealer for service.
- For adult use only. Infinity must be installed out of the reach of children. Never leave the unit running unattended.
- Never attempt to bypass the thermostatic switch or fuses.
- For replacement use fuses of same type and rating only.
- The user is responsible for correct positioning and operating of the Infinity. The manufacturer will not accept liability for damages caused by the misuse or incorrect installation of this device.
- This device falls under protection class I. Therefore it is essential to connect the yellow/green conductor to earth.
- Repairs, servicing and electric connection must be carried out by a qualified technician.
- WARRANTY: Till one year after date of purchase.

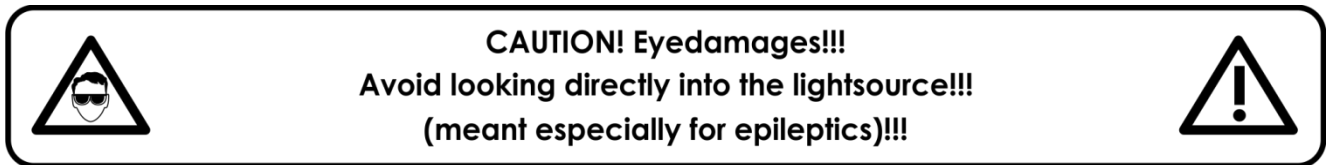

Operating Determinations

- This device is not designed for permanent operation. Consistent operation breaks will ensure that the device will serve you for a long time without defects.
- The minimum distance between light output and the illuminated surface must be more than 1 meter.
- The maximum ambient temperature $t_a = 40^\circ\text{C}$ must never be exceeded.
- The relative humidity must not exceed 50 % with an ambient temperature of 40°C .
- If this device is operated in any other way than the one described in this manual, the product may suffer damages and the warranty becomes void.
- Any other operation may lead to dangers like short-circuit, burns, electric shock, crash etc.

You endanger your own safety and the safety of others!

Rigging

Please follow the European and national guidelines concerning rigging, trussing and all other safety issues.

Do not attempt the installation yourself!

Always have the inspections carried out by an authorized dealer!

Procedure:

- If the projector is lowered from the ceiling or high joists, professional trussing systems have to be used.
- Use a clamp to mount the projector, with the mounting bracket, to the trussing system.
- The projector must never be fixed swinging freely in the room.
- The installation must always be secured with a safety attachment, e.g. an appropriate safety net or safety cable.
- When rigging, derigging or servicing the projector, always make sure, that the area below the installation site is secured and that there are not any unauthorized people around.

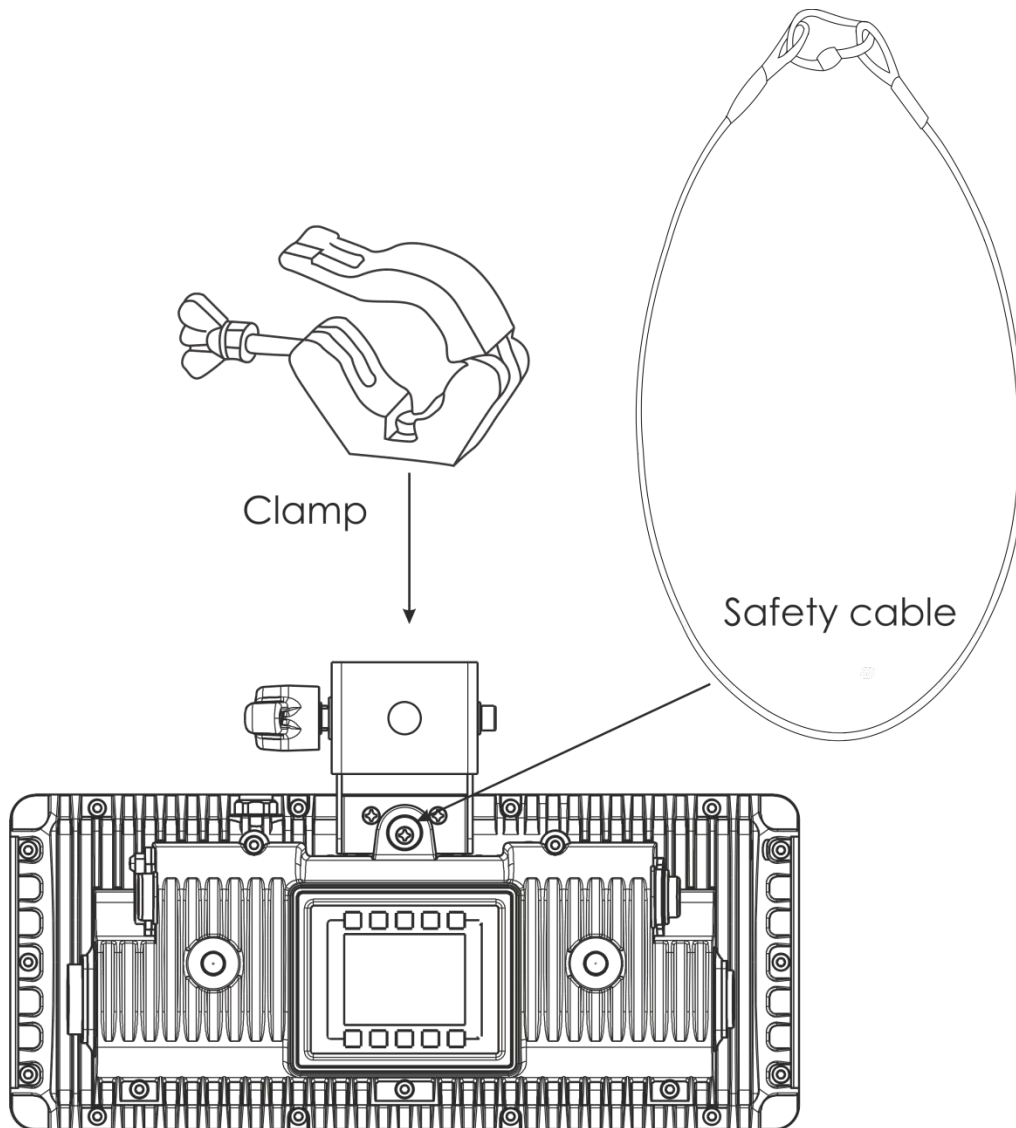

The Infinity can be placed on a flat stage floor or mounted to any kind of truss with a clamp.

Improper installation can cause serious injuries and/or damage of property!

Connection with the mains

Connect the device to the mains with the power-plug.

Always check if the right color cable is connected to the right place.

International	EU Cable	UK Cable	US Cable	Pin
L	BROWN	RED	YELLOW/COPPER	PHASE
N	BLUE	BLACK	SILVER	NEUTRAL
⊕	YELLOW/GREEN	GREEN	GREEN	PROTECTIVE GROUND

Make sure that the device is always properly connected to the earth!

Improper installation can cause serious injuries and/or damage of property!



Return Procedure



Returned merchandise must be sent prepaid and in the original packing, call tags will not be issued. Package must be clearly labeled with a Return Authorization Number (RMA number). Products returned without an RMA number will be refused. Highlite will not accept the returned goods or any responsibility. Call Highlite 0031-455667723 or mail aftersales@highlite.nl and request an RMA prior to shipping the fixture. Be prepared to provide the model number, serial number and a brief description of the cause for the return. Be sure to properly pack fixture, any shipping damage resulting from inadequate packaging is the customer's responsibility. Highlite reserves the right to use its own discretion to repair or replace product(s). As a suggestion, proper UPS packing or double-boxing is always a safe method to use.

Note: If you are given an RMA number, please include the following information on a piece of paper inside the box:

- 01) Your name
- 02) Your address
- 03) Your phone number
- 04) A brief description of the symptoms

Claims

The client has the obligation to check the delivered goods immediately upon delivery for any shortcomings and/or visible defects, or perform this check after our announcement that the goods are at their disposal. Damage incurred in shipping is the responsibility of the shipper; therefore the damage must be reported to the carrier upon receipt of merchandise.

It is the customer's responsibility to notify and submit claims with the shipper in the event that a fixture is damaged due to shipping. Transportation damage has to be reported to us within one day after receipt of the delivery.

Any return shipment has to be made post-paid at all times. Return shipments must be accompanied with a letter defining the reason for return shipment. Non-prepaid return shipments will be refused, unless otherwise agreed in writing.

Complaints against us must be made known in writing or by fax within 10 working days after receipt of the invoice. After this period complaints will not be handled anymore.

Complaints will only then be considered if the client has so far complied with all parts of the agreement, regardless of the agreement of which the obligation is resulting.

Description of the device

Features

The Infinity XPLO-15 LED Strobe is a professional strobe effect for the most demanding users.

- Input voltage: 100-240V, 60/50Hz
- Power consumption: 132W
- DMX channels: 1, 3, 4, 6 (16-bit Control), 28 (Zone Mapping) channels
- LCD display with gravity sensor
- Light source: 576 x 6500K Luxeon SMD
- Light output: 28000 lux
- Color temperature: 6500K
- Control modes: Stand-alone, Master/Slave, DMX/RDM
- Control protocol: DMX-512, RDM
- Dimmer: 0-100%
- Strobe: 0,5-30Hz
- Dimming Curves: Dimming curves: Linear, PL-Curve, S-Curve, Square-Curve
- Beam Angle: 115°
- IP rating: IP54
- Housing: Metal & Flame retardant plastic
- Connections: Neutrik True1 and 3-pin XLR IN/OUT
- Dimensions: 319 x 130 x 255 mm (LxWxH)
- Weight: 5,4 kg

Frontside

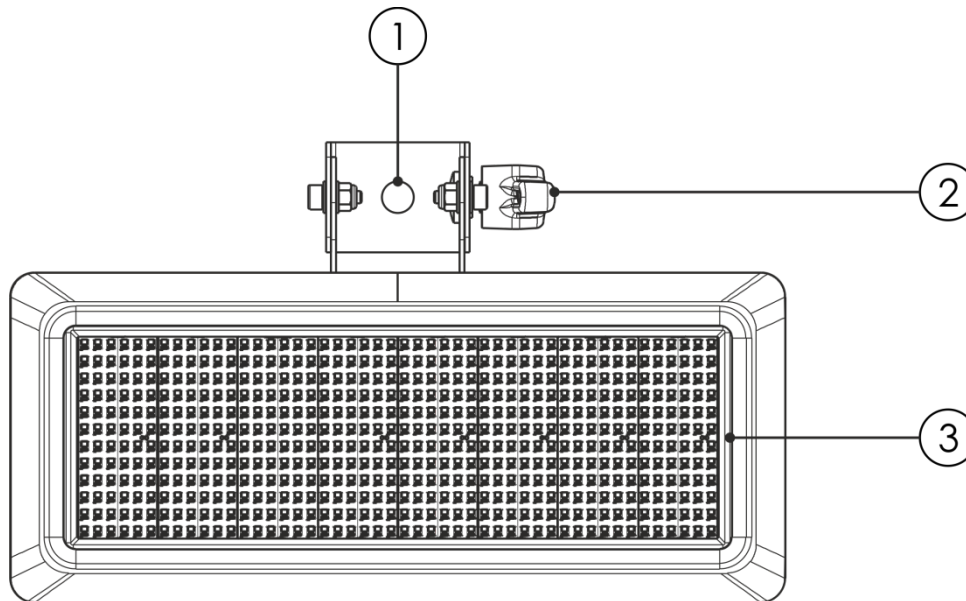

Fig. 01

- 01) Mounting bracket with inclination screw
- 02) Adjustment screw
- 03) 576 x 6500K Luxeon SMD

Backside

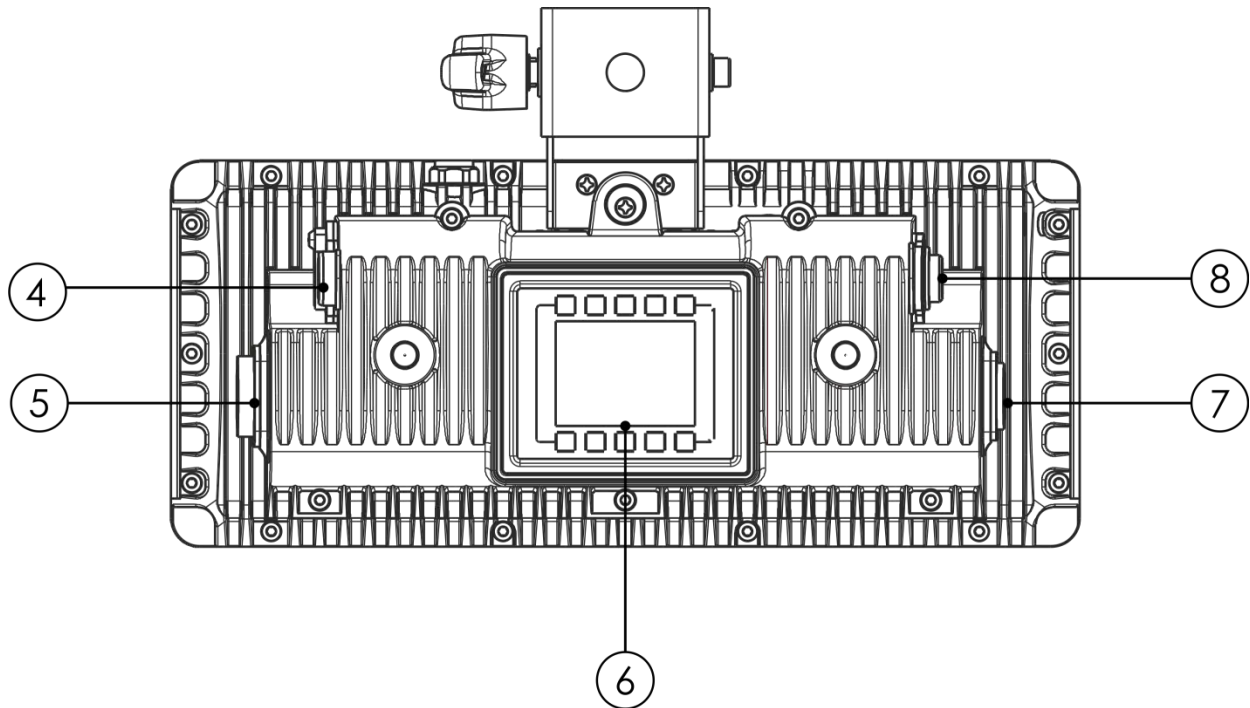

Fig. 02

- 04) 3-pin DMX/RDM signal connector OUT
- 05) Neutrik True1 power connector 100-240V OUT
- 06) LCD Display + control buttons
- 07) Neutrik True1 power connector 100-240V IN
- 08) 3-pin DMX/RDM signal connector IN

Installation

Remove all packing materials from the Infinity XPLO-15 LED Strobe. Check if all foam and plastic padding is removed. Connect all cables.

Do not supply power before the whole system is set up and connected properly.

Always disconnect from electric mains power supply before cleaning or servicing.

Damages caused by non-observance are not subject to warranty.

Set Up and Operation

Follow the directions below, as they pertain to your preferred operation mode.

Before plugging the unit in, always make sure that the power supply matches the product specification voltage. Do not attempt to operate a 120V specification product on 230V power, or vice versa.

Connect the device to the main power supply.

Control Modes

There are 3 modes:

- Stand-alone
- Master/Slave
- DMX-512 (1CH, 3CH, 4CH, 6CH, 28CH)

One Infinity (Stand-alone)

- 01) Fasten the effect light to a firm trussing. Leave at least 0,5 meter on all sides for air circulation.
- 02) Plug the end of the electric mains power cord into a proper electric power supply socket.
- 03) When the Infinity is not connected with a DMX cable, it functions as a stand-alone device.
Please see pages 17-29 for more information about the Stand-alone Mode.

Multiple Infinities (Master/Slave control)

- 01) Fasten the effect light onto firm trussing. Leave at least 0,5 meter on all sides for air circulation.
- 02) Use a 3-pin XLR cable to connect the Infinity.

The pins:



- 01) Earth
- 02) Signal -
- 03) Signal +

- 03) Link the units as shown in fig. 03. Connect the first unit's DMX "out" socket with the second unit's "in" socket, using a DMX-signal cable. Repeat this process to link the second, third, and fourth units. You can use the same functions on the master device as described on pages 17-29 (Stand-alone Mode). This means that you can set your desired operation mode on the master device and all slave devices will react the same as the master device.

Multiple Infinities (Master/Slave control)

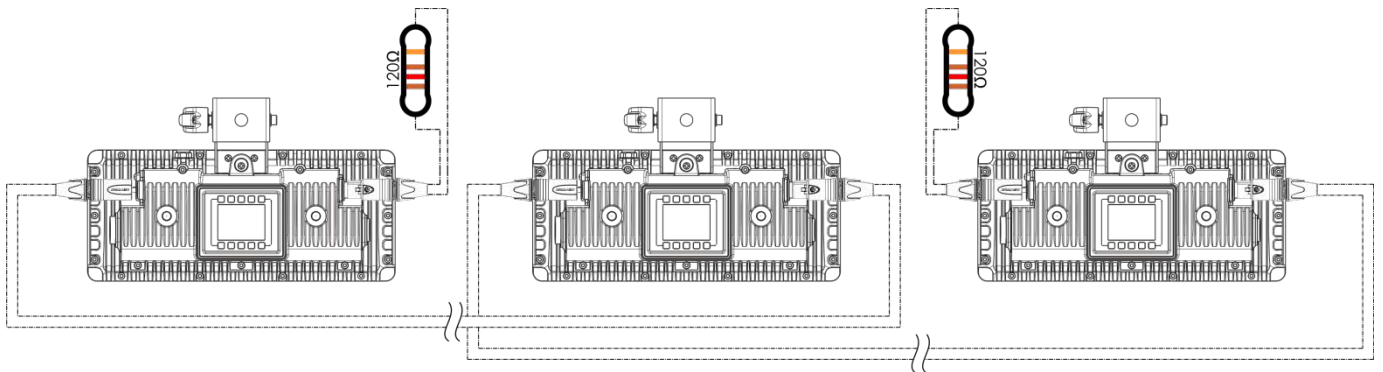
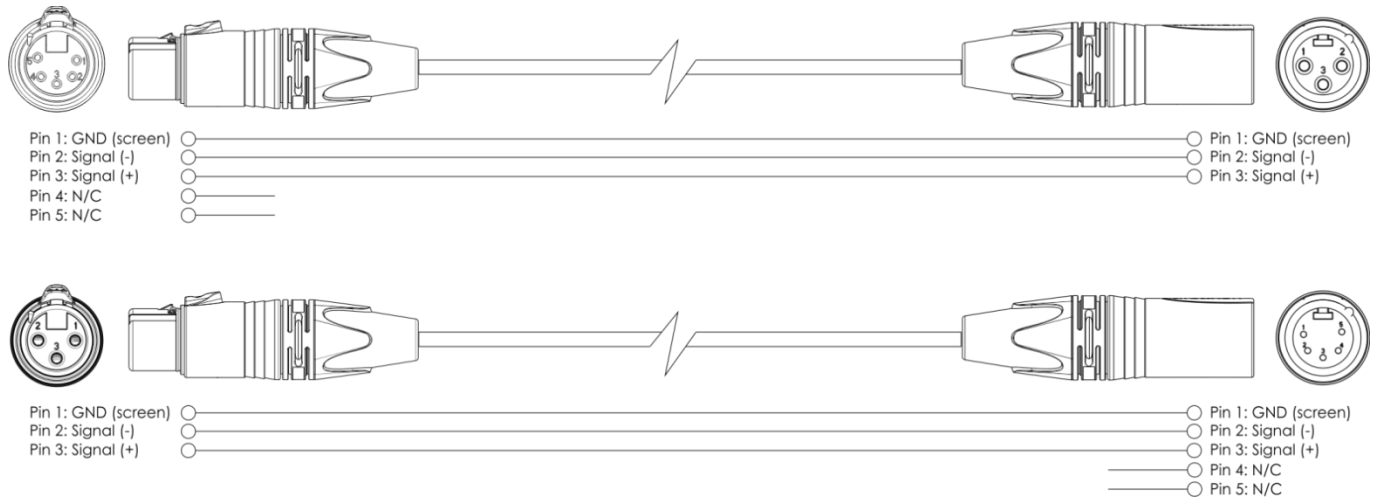

Fig. 03

Multiple Infinitys (DMX Control)

- 01) Fasten the effect light to a firm trussing. Leave at least 0,5 meter on all sides for air circulation.
- 02) Always use a safety cable (ordercode 70140 / 70141).
- 03) Use a 3-pin XLR cable to connect the Infinity and other devices.



- 04) Link the units as shown in fig. 04. Connect the first unit's DMX "out" socket with the second unit's "in" socket, using a DMX-signal cable. Repeat this process to link the second, third, and fourth units.
- 05) Supply electric power: Plug electric mains power cords into each unit's Neutrik True1 socket, then plug the other end of the mains power cord into proper electric power supply sockets, starting with the first unit. Do not supply power before the whole system is set up and connected properly.

Multiple Infinitys DMX Set Up

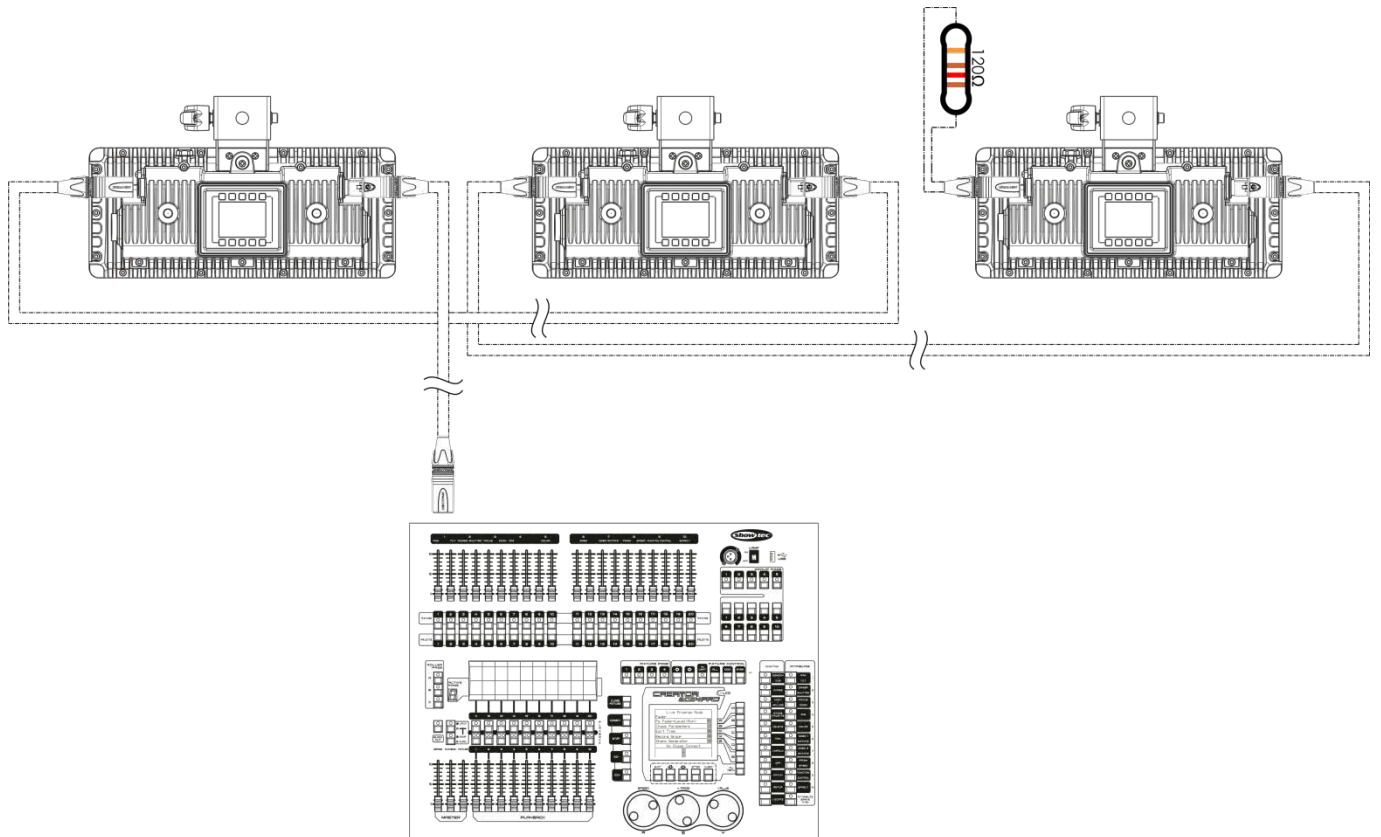



Fig. 04

Note : Link all cables before connecting electric power

Fixture Linking

You will need a serial data link to run light shows of one or more fixtures using a DMX-512 controller or to run synchronized shows of two or more fixtures set to a master/slave operating mode. The combined number of channels required by all the fixtures on a serial data link determines the number of fixtures the data link can support.

Important: Fixtures on a serial data link must be daisy-chained in a single line. To comply with the EIA-485 standard, no more than 30 devices should be connected on one data link. Connecting more than 30 fixtures on one serial data link without the use of a DMX optically isolated splitter may result in deterioration of the digital DMX signal.

 Maximum recommended DMX data link distance: 100 meters
Maximum recommended number of fixtures on a DMX data link: 30 fixtures
Maximum recommended number of fixtures on a power link: 13 fixtures @ 100V
Maximum recommended number of fixtures on a power link: 26 fixtures @ 240V

Data Cabling

To link fixtures together, you must obtain data cables. You can purchase DAP Audio certified DMX cables directly from a dealer/distributor or construct your own cable. If you choose to create your own cable, please use data-grade cables that can carry a high quality signal and are less prone to electromagnetic interference.

DAP Audio DMX Data Cables

- DAP Audio Basic microphone cable for allround use. bal. XLR/M 3-pin > XLR/F 3-pin. **Ordercode** FL01150 (1,5 m), FL013 (3 m), FL016 (6 m), FL0110 (10 m), FL0115 (15 m), FL0120 (20 m).
- DAP Audio X-type data cable XLR/M 3-pin > XLR/F 3-pin. **Ordercode** FLX0175 (0,75 m), FLX01150 (1,5 m), FLX013 (3 m), FLX016 (6 m), FLX0110 (10 m).
- DAP Audio cable for the demanding user with exceptional audio-qualities and connector made by Neutrik®. **Ordercode** FL71150 (1,5 m), FL713 (3 m), FL716 (6 m), FL7110 (10 m).
- DAP Audio cable for the demanding user with exceptional audio-qualities and connector made by Neutrik®. **Ordercode** FL7275 (0,75 m), FL72150 (1,5 m), FL723 (3 m), FL726 (6 m), FL7210 (10 m).
- DAP Audio 110 Ohm cable with digital signal transmission. **Ordercode** FL0975 (0,75 m), FL09150 (1,5 m), FL093 (3 m), FL096 (6 m), FL0910 (10 m), FL0915 (15 m), FL0920 (20 m).

Control Panel

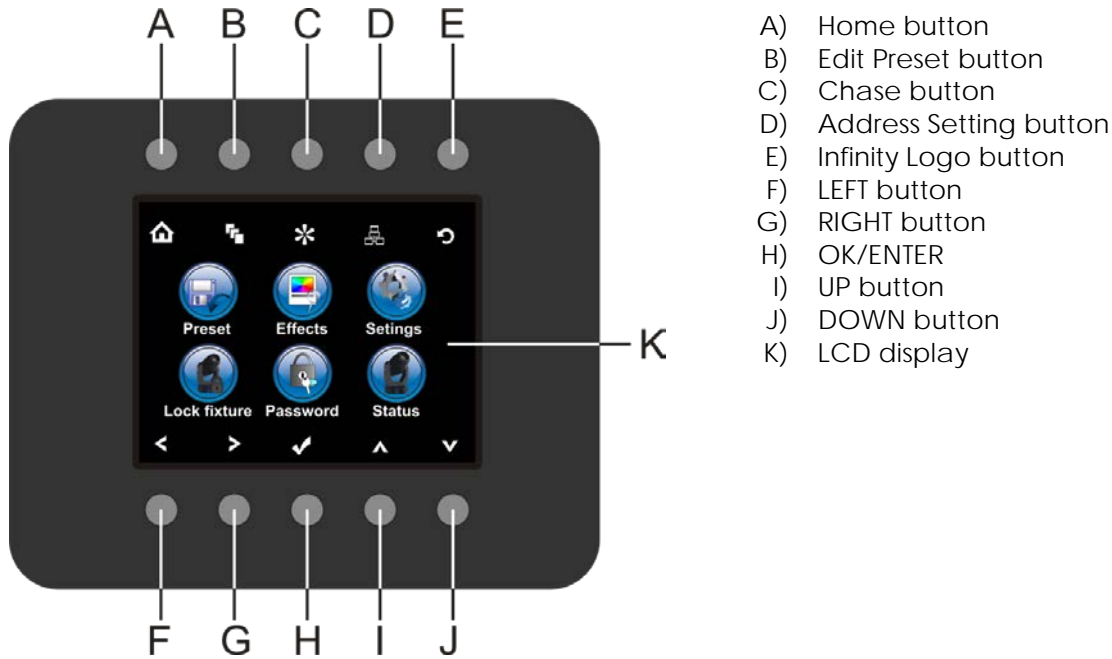

Fig. 05

Control Mode

The fixtures are individually addressed on a data-link and connected to the controller. The fixtures respond to the DMX signal from the controller. (When you select the DMX address and save it, the controller will display the saved DMX address the next time.)

DMX Addressing

The control panel on the front side of the base allows you to assign the DMX fixture address, which is the first channel from which the Infinity will respond to the controller. Please note when you use the controller, the unit has **28** channels. When using multiple Infinity's, make sure you set the DMX addresses right. Therefore, the DMX address of the first Infinity should be **1(001)**; the DMX address of the second Infinity should be **1+28=29 (029)**; the DMX address of the third Infinity should be **29+28=57 (057)**, etc. Please, be sure that you don't have any overlapping channels in order to control each Infinity correctly. If two or more Infinity's are addressed similarly, they will work similarly.

Controlling:

After having addressed all Infinity fixtures, you may now start operating these via your lighting controller. **Note:** After switching on, the Infinity will automatically detect whether DMX 512 data is received or not. If there is no data received at the DMX-input, the "LED" on the control panel will not flash.

The problem may be:

- The XLR cable from the controller is not connected with the input of the Infinity.
- The controller is switched off or defective, the cable or connector is defective, or the signal wires are swapped in the input connector.

Note: It's necessary to insert a XLR termination plug (with 120 Ohm) in the last fixture in order to ensure proper transmission on the DMX data link.

⚠ Display Off after 35 seconds ⚠

When no button is pressed for 35 seconds, the display will turn off. To light up the display, you have to press one of the 10 buttons on the control panel.. Once you have pressed the button, the display will light up.

Menu Overview

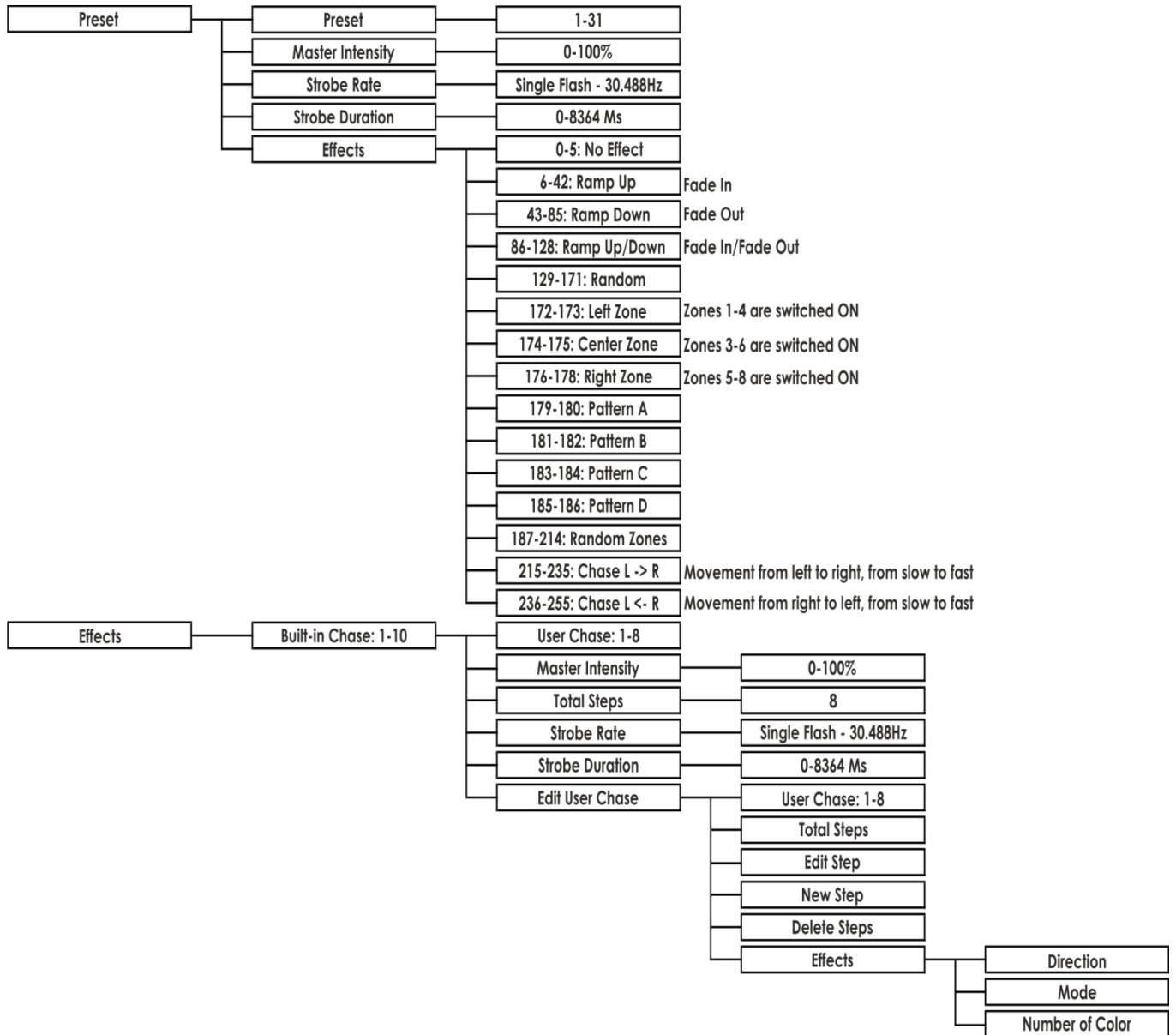

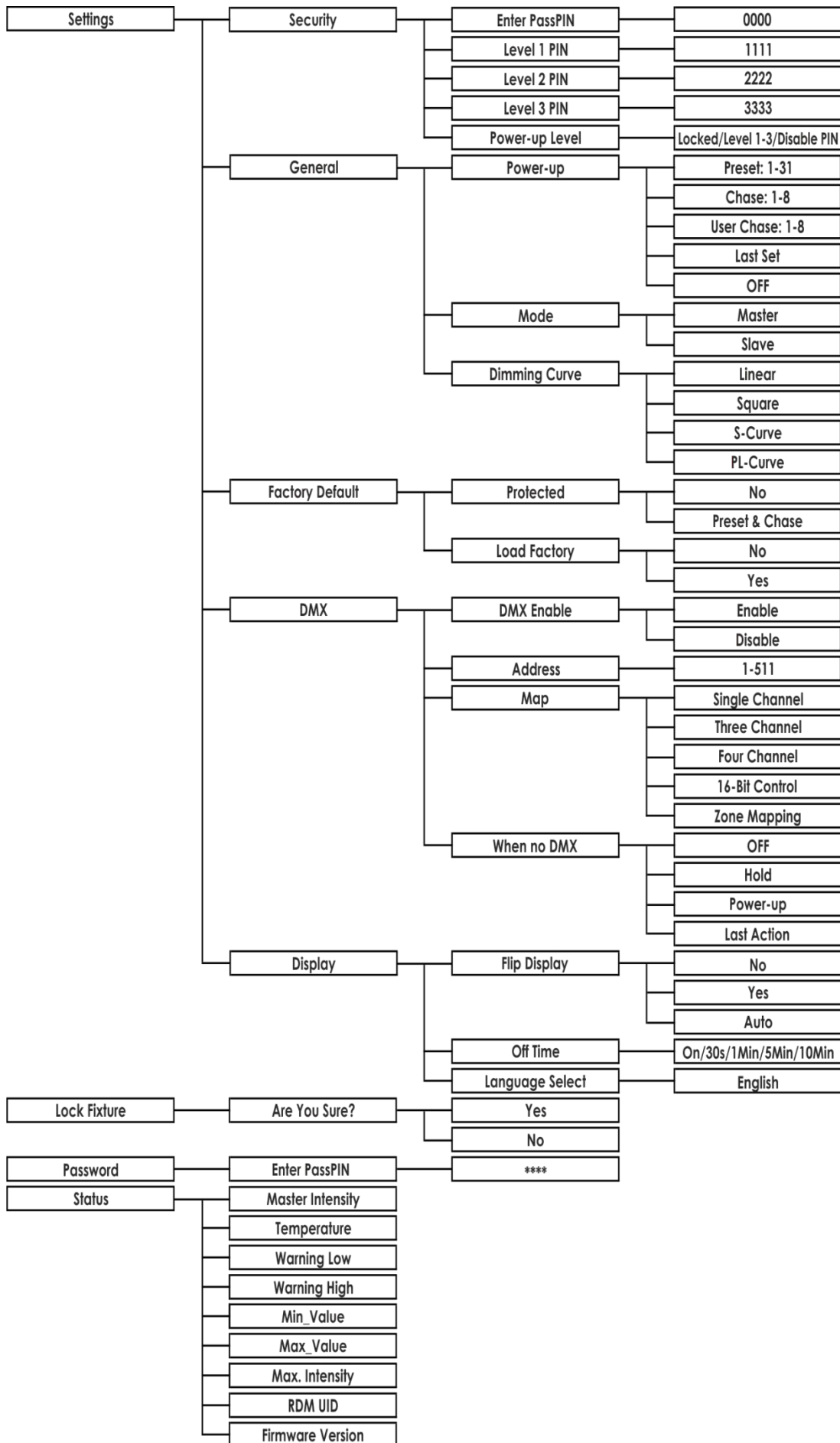

Main Menu Options



Presets



Chases



Settings Menu



Fixture Lock



Password

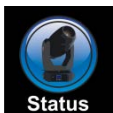

System Status



Home



Up



Presets



Down



Chases



OK



DMX Address Setting



Left



Main Screen



Right







The device's output is divided into zones. In the example below, zones 2, 3, 5, 7 and 8 are switched ON.

Zone 1 Zone 2 Zone 3 Zone 4 Zone 5 Zone 6 Zone 7 Zone 8



1. Presets

1.1. Editing a preset

01) While in the main menu, press the , ,  and  buttons to choose  and press the  button to open the menu. You can also press the  button. The display will show:

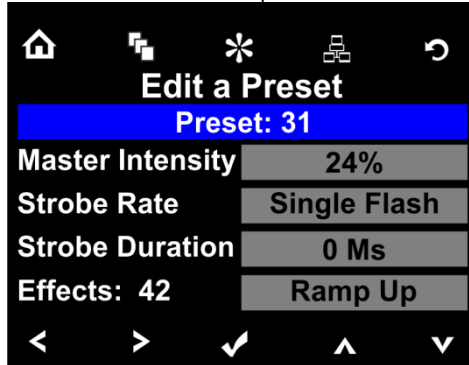

02) Press the  and  to toggle between the following options:

- Preset (Choose between 31 built-in presets or OFF)
- Master Intensity (Dimmer intensity, between 0-100%, from low to high intensity)
- Strobe Rate (Strobe intensity, between Single Flash - 30,488Hz)
- Strobe Duration (Between 0-8364Ms, from short to long duration)
- Effects (see below)

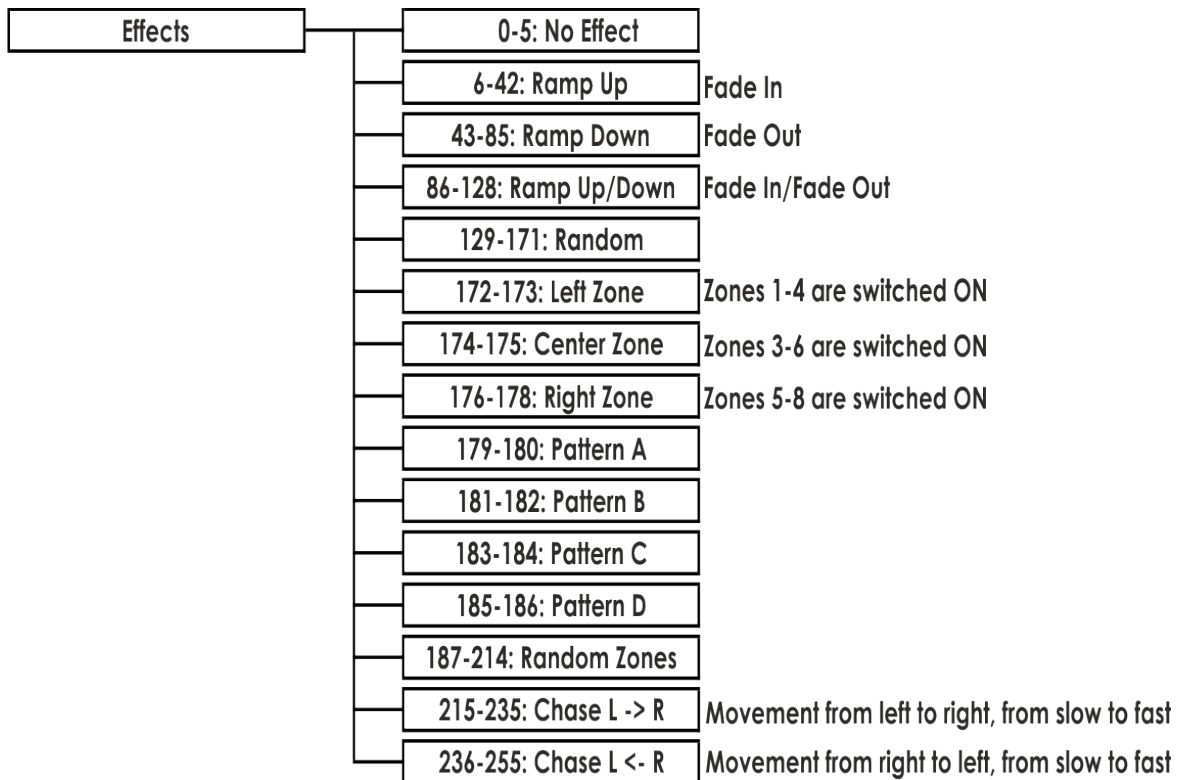

03) Press the  and  buttons to, respectively, decrease/increase the values.

04) Press the  button to proceed to zone edition. The display will show:

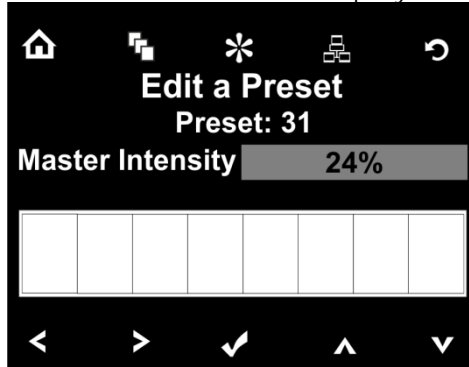



05) Press the  and  buttons to switch between the zones.

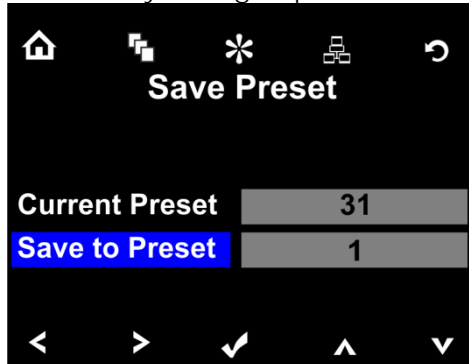

06) Press the  and  to switch the zones ON or OFF.

07) Once you have applied all the necessary changes, press the  to confirm. The display will show:









08) Press the  and  buttons to choose the preset which you wish to overwrite.

09) Press the  to confirm.



10) Press the  and  buttons to choose YES or NO, when asked if you are sure that you want to save the preset and press the  button to confirm.

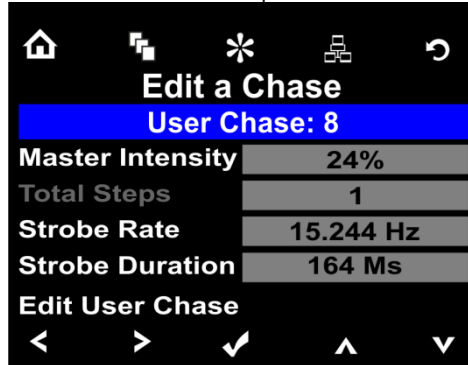

2. Chases

2.1. Editing a chase



01) While in the main menu, press the , ,  and  buttons to choose  and press the  button to open the menu. You can also press the  button. The display will show:

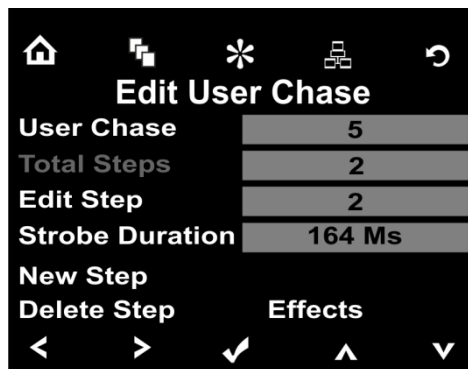

02) Press the  and  buttons to choose one of the 10 built-in chases or one of the 8 user chases. **Note:** If you have chosen a user chase, you can edit its characteristics.

03) Press the  and  to choose Edit User Chase and press the  button to confirm. The display will show:



04) Press the  and  buttons to toggle between the following options.









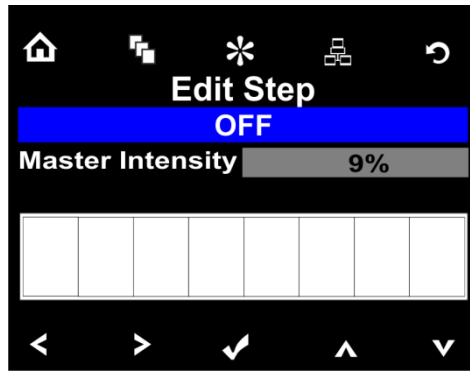



- User Chase (Choose one of the 8 user chases)
- Edit Step (Edit the characteristics of the desired step)
- Strobe Duration (Between 0-8364Ms, from short to long duration)
- New Step (Add new step)
- Delete Step
- Effects (Edit the chase's characteristics)

05) Press the  and  buttons, to adjust the values.

06) Press the  and  buttons to choose Edit Step and press the  and  buttons to choose the step which you want to edit.

07) Press the  button to enter edition mode. The display will show:

























- 08) Press the  and  buttons to choose one of the existing presets which, later on, can be edited. There are 31 presets to choose from.
- 09) Press the  and  buttons to choose Master Intensity.
- 10) Press the  and  buttons to adjust the dimmer intensity. The adjustment range is between 0-100%.
- 11) Press the  and  buttons to enter the zone preview mode.
- 12) Press the  and  buttons to choose one of the 8 zones which you want to activate/deactivate.
- 13) Press the  and  buttons to activate/deactivate the desired zone.
- 14) Press the  button to save changes.

2.2. Editing an effect

- 01) Return to step 4 (page 19) and choose Effects. Press the  button to confirm. The display will show:



- 02) Press the  and  buttons to choose Direction.
- 03) Press the  and  buttons to choose Left or Right. The effect will now move to the left or to the right.
- 04) Press the  and  buttons to choose Mode.
- 05) Press the  and  buttons to choose one of the 2 modes.
- 06) Press the  and  buttons to choose Number of Color.
- 07) Press the  and  buttons to adjust the number of the active zones. The adjustment range is between 1-8. 1 = all zones active, 8 = one zone active.
- 08) Press the  and  buttons to choose zone preview mode.

- 09) Press the  and  buttons to choose one of the 8 zones which you want to activate/deactivate.
- 10) Press the  and  buttons to activate/deactivate the desired zone.
- 11) Press the  button to save changes.
- 12) Press the  and  buttons to choose Yes or No, when asked if you are sure that you want to save changes, and press the  button to confirm your choice.





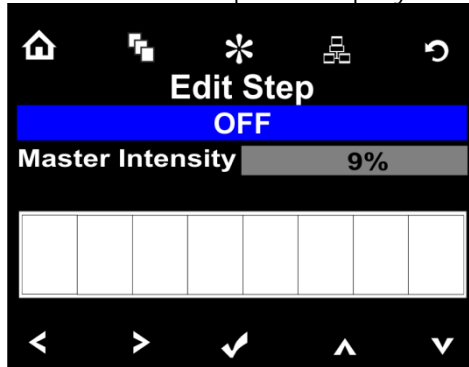

2.3. Adding a new step

01) Return to step 4 (page 19) and choose New Step. The display will show:



02) Repeat steps 8-14 (pages 19-20) to create a new step.



2.4. Deleting a step

- 01) Return to step 4 (page 19).
- 02) Press the  and  buttons to choose Edit Step.
- 03) Press the  and  buttons to choose the step which you want to delete.
- 04) Press the  and  buttons to choose Delete Step and press the  button to delete the desired step.

3. Settings

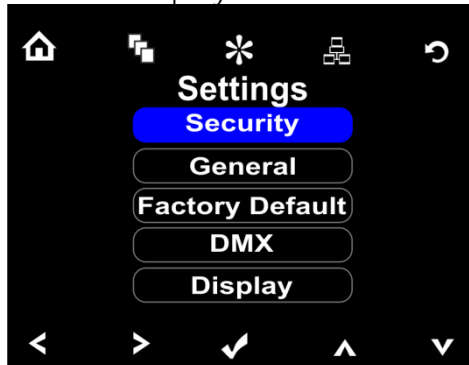

01) While in the main menu, press the , ,  and  buttons to choose  and press the  button to open the menu. The display will show:





02) Press the  and  buttons to toggle between the 5 options:

- Security
- General
- Factory Default
- DMX
- Display

3.1. Security

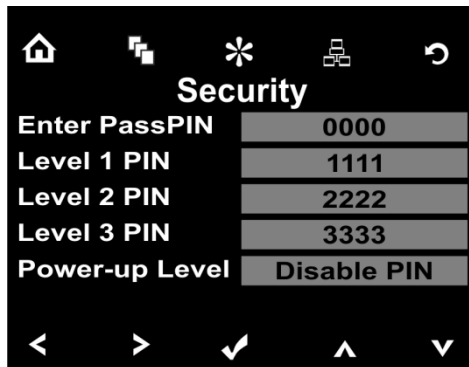





01) Press the  and  buttons to choose Security and press the  button to enter the menu. The display will show:

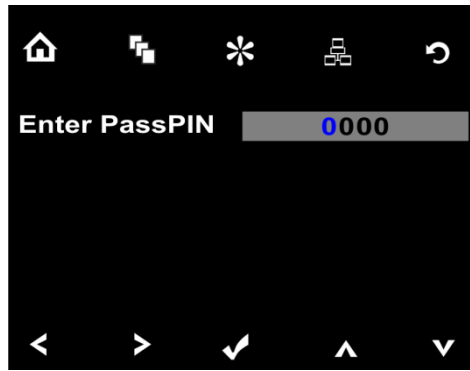

02) Press the  and  buttons to toggle between the available options.

03) In order to adjustChoose one of the 5 safety keys (Enter PassPIN, Level 1 PIN, Level 2 PIN, Level 3 PIN or Power-up Level) and press the  button to open the menu. For example, if you choose Enter PassPIN, the display will show:





- 04) Press the  and  buttons to choose the digit which you want to edit. The chosen digit will light up in blue.
- 05) Press the  and  buttons to adjust the value. The adjustment range is between 0-9.
- 06) Once the security key has been inserted, press the  button to store it.
- 07) Return to step 3 and choose Power-up Level.
- 08) Press the  and  buttons to choose the password which will be needed to unlock the device on the next start-up.

3.2. General

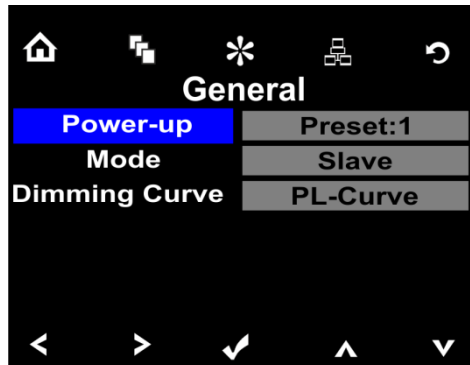
- 01) Press the  and  buttons to choose General and press the  button to enter the menu. The display will show:



- 02) Press the  and  buttons to toggle between the following available options:
 - Power-up (Choose between 31 presets, 10 chases, 8 user chases, Last Setting or OFF)
 - Mode (Set the device as a master or a slave device.)

Note: In order to be able to adjust the device's functions by means of DMX, the device **must be** set to **Master**.

- Dimming Curve (Choose between PL-Curve, Linear-Curve, Square-Curve or S-Curve. See the chart below, describing differences between the particular dimming curve patterns.)

- 03) Press the  and  buttons to adjust the options.

Dimming Curves

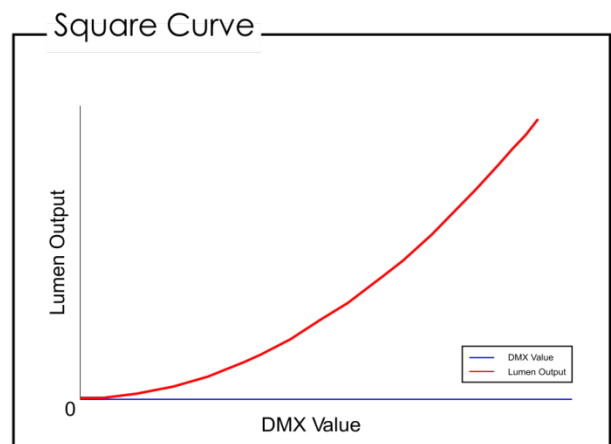
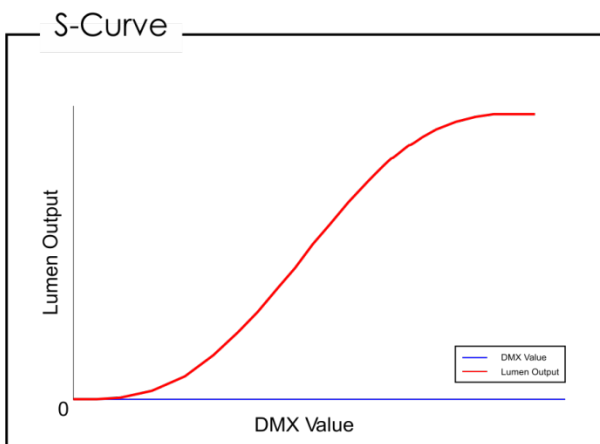
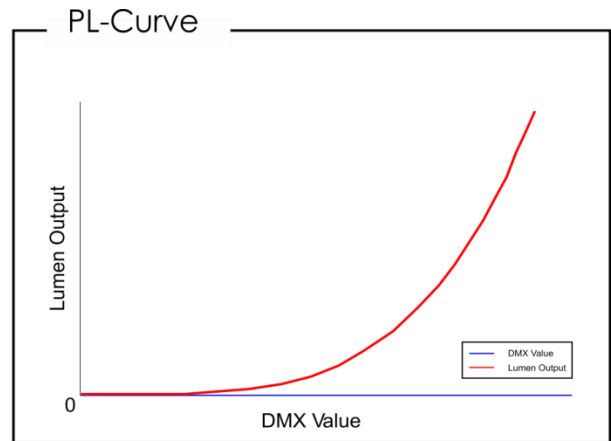
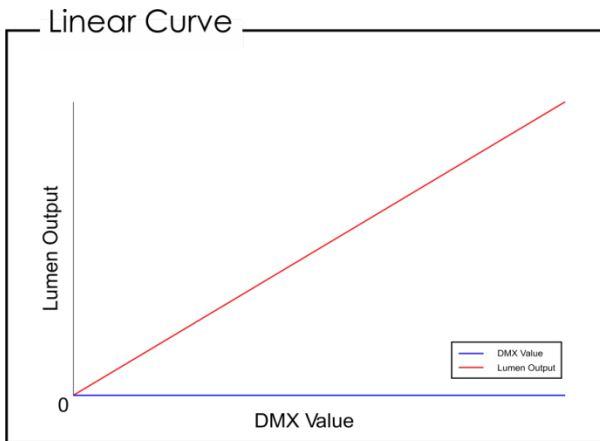



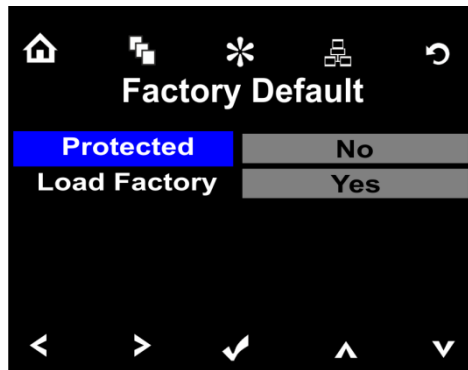



Fig. 06





3.3. Factory Default

01) Press the , ,  to choose Factory Default and press the  button to enter the menu. The display will show:



02) Press the  and  buttons to toggle between the following available options:



- Protected
- Load Factory

03) Press the  and  buttons to choose Protected and press the  and  buttons to choose between No or Preset&Chase. This option defines whether the whole menu or only the Settings menu are locked, providing that the safety lock has been activated.

04) Press the  and  buttons to choose Load Factory.

05) Press the  and  buttons to choose between YES and NO.



06) Press the  button to confirm your choice.

07) If you have chosen YES, you will again have to choose between YES or NO, when asked if you are sure of your choice. Press the  and  buttons to make your choice.



08) Press the  button to confirm.

09) The device will now perform a software reset.

3.4. DMX Mode

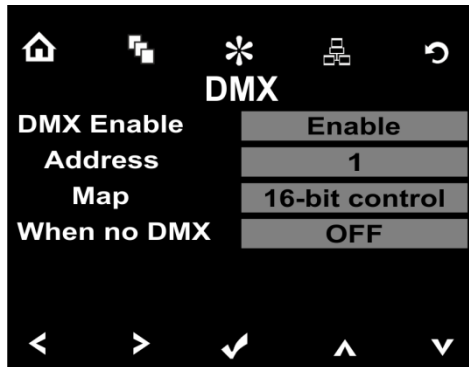
01) Press the  and  buttons to choose DMX and press the  button to enter the menu. The display will show:



02) Press the  and  buttons to toggle between the following 4 options:

- DMX Enable (Choose between Enable and Disable, to activate/deactivate DMX.)
- Address (Set the desired DMX address. The adjustment range is between 1-511, depending on the active channel mode.)
- Map (Choose between 5 channel modes: Single channel, Three Channel, Four Channel, 16-bit Control, Zone Mapping.)
- When no DMX (Choose between OFF, Hold, Power-up and Last Action. See below for more information.)

OFF

When the device is not receiving a DMX signal, the output will be switched OFF.

Hold

When the device is not receiving a DMX signal, it will fall back on the last working DMX signal.

Power-up

When the device is not receiving a DMX signal, it will fall back on the power-up value from Settings menu.

Last Action

When the device is not receiving a DMX signal, it will restore the last menu action.

03) Press the  and  buttons to adjust the chosen options.

04) Once all the necessary changes have been made, press the  button to confirm.

3.5. DMX Address Setting

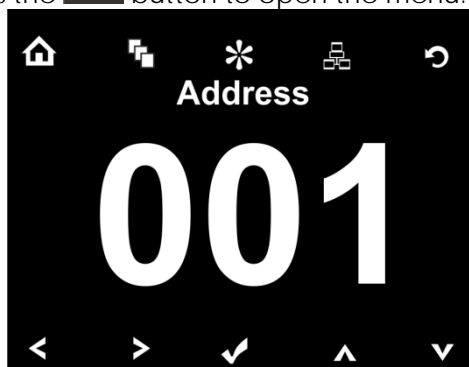

01) While in the main menu, press the  button to open the menu. The display will show:



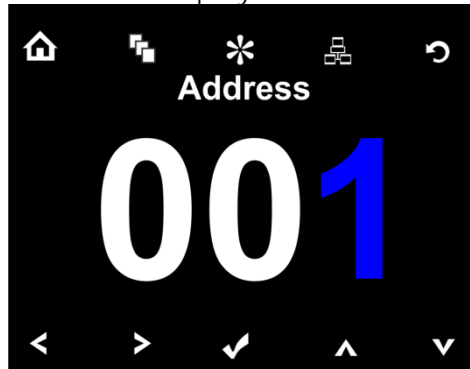

02) Press the  to enter edition mode. The display will show:





03) Press the  and  buttons to adjust the chosen digit (which lights up in blue).

04) Press the  and  buttons to choose another digit to edit and repeat the previous step.

3.6. Display

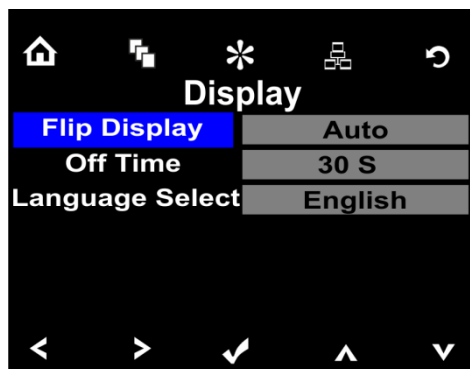
01) Press the  and  buttons to choose Display and press the  button to enter the menu. The display will show:



02) Press the  and  buttons to toggle between the following options:



- Flip Display (Choose between Auto – automatic flip; No – no flip; Yes – horizontal flip)
- Off Time (Time after which the display turns off, when no button is pressed. The available options are: ON – display continuously ON, 30s, 1min, 5min, 10min)
- Language Select (Select your preferred language. In this software version, English is the only option.)

03) Press the  and  buttons to adjust the chosen options.



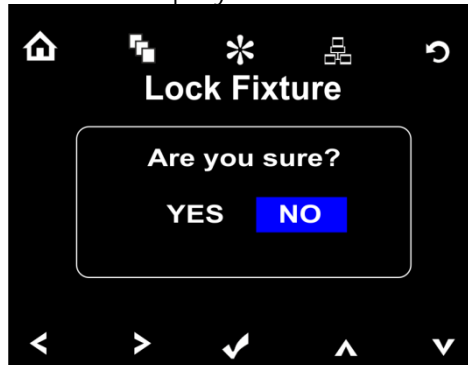







4. Fixture Lock

- 01) While in the main menu, press the , ,  and  buttons to choose  and press the  button to open the menu. The display will show:









- 02) Press the  and  buttons to choose either Yes or No.
- 03) Press the  button to confirm your choice.
- 04) If you have chosen Yes, the device will return to the main screen.
- 05) If you want to enter the menu, you are now obliged to insert the security key (see page 22).

5. Password

- 01) While in the main menu, press the , ,  and  buttons to choose  and press the  button to open the menu.
- 02) You will now be asked to insert the security key.
- 03) Press the  and  buttons to choose the digit which you want to edit. The chosen digit will light up in blue.
- 04) Press the  and  buttons to adjust the value. The adjustment range is between 0-9.
- 05) Once the security key has been inserted, press the  button to confirm.

6. Status

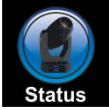
In this menu you can see the current status of the device.

01) While in the main menu, press the , ,  and  buttons to choose  and press the  button to open the menu. The display will show:

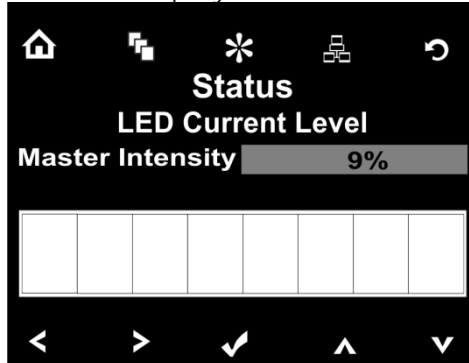

02) The display shows the current dimmer intensity, as well as the current zone preview.

03) Press the  button to proceed to the second screen. The display will show:

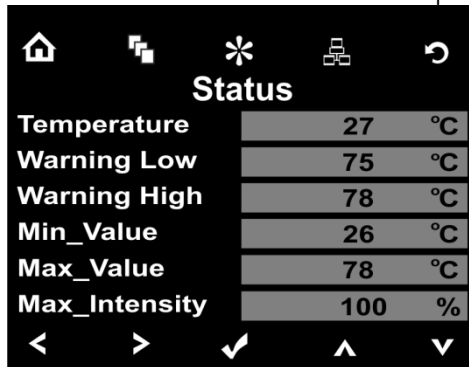

04) The pieces of information displayed on the screen are as follows:

- Temperature (The current temperature of the device)
- Warning Low (The temperature which triggers low priority overheating alarm)
- Warning High (The temperature which triggers high priority overheating alarm)
- Min_Value (The lowest temperature which ensures proper performance of the device)
- Max_Value (The highest temperature which ensures proper performance of the device)
- Max_Intensity (The maximum available dimmer intensity)

05) Press the  button to proceed to the third screen. The display will show:



06) The pieces of information displayed on the screen are as follows:

- RDM UID (The current RDM software version)
- Firmware Version (The current software version)

DMX Channels

The device's output is divided into zones. In the example below, zones 2, 3, 5, 7 and 8 are switched ON.



1 channel (Single Channel)

Channel 1 – Strobe

0-255 Strobe flash frequency, from slow to fast

3 channels (Three Channel)

Channel 1 – Dimmer intensity

0-255 Gradual adjustment, from dark to brightest 0-100%

Channel 2 – Strobe Duration Dimmer must be open

0-255 Strobe flash duration, from short to long

Channel 3 – Strobe Dimmer must be open

0-255 Strobe flash frequency, from low to high frequency

4 channels (Four Channel)

Channel 1 – Dimmer intensity

0-255 Gradual adjustment, from dark to brightest 0-100%

Channel 2 – Strobe Duration Dimmer must be open

0-255 Strobe flash duration, from short to long

Channel 3 – Strobe Dimmer must be open

0-255 Strobe flash frequency, from low to high frequency

Channel 4 – Effects Dimmer must be open

0-5	Not functional
6-42	Ramp Up (Fade In)
43-85	Ramp Down (Fade Out)
86-128	Ramp up/down (Fade In/Out)
129-171	Random effects
172-173	Left zone
174-175	Center zone
176-178	Right zone
179-180	Pattern A
181-182	Pattern B
183-184	Pattern C
185-186	Pattern D

187-214	Random patterns
215-235	Chase 1 - from left to right, from slow to fast
236-255	Chase 2 - from right to left, from slow to fast

6 channels (16-bit Control)

Channel 1 – Dimmer intensity

0-255	Gradual adjustment, from dark to brightest 0-100%
-------	---

Channel 2 – 16-bit dimmer intensity

0-255	Gradual adjustment, from dark to brightest 0-100%
-------	---

Channel 3 – Effects Dimmer must be open

0-5	Not functional
6-42	Ramp Up (Fade In)
43-85	Ramp Down (Fade Out)
86-128	Ramp up/down (Fade In/Out)
129-171	Random effects
172-173	Left zone
174-175	Center zone
176-178	Right zone
179-180	Pattern A
181-182	Pattern B
183-184	Pattern C
185-186	Pattern D
187-214	Random patterns
215-235	Chase 1 - from left to right, from slow to fast
236-255	Chase 2 - from right to left, from slow to fast

Channel 4 – Dimming curves Dimmer must be open

0-4	Default
5-29	Not functional
30-34	Linear dimming curve
35-39	Square dimming curve
40-44	S-Curve dimming curve
45-49	PL-Curve dimming curve
50-255	Not functional

Channel 5 – Strobe Duration Dimmer must be open

0-255	Strobe flash duration, from short to long
-------	---

Channel 6 – Strobe Dimmer must be open

0-255	Strobe flash frequency, from low to high frequency
-------	--

28 channels (Zone Mapping)

Channel 1 – Dimmer intensity

0-255 Gradual adjustment, from dark to brightest 0-100%

Channel 2 – 16-bit dimmer intensity

0-255 Gradual adjustment, from dark to brightest 0-100%

Channel 3 – Effects Dimmer must be open

0-5 Not functional

6-42 Ramp Up (Fade In)

43-85 Ramp Down (Fade Out)

86-128 Ramp up/down (Fade In/Out)

129-171 Random effects

172-173 Left zone

174-175 Center zone

176-178 Right zone

179-180 Pattern A

181-182 Pattern B

183-184 Pattern C

185-186 Pattern D

187-214 Random patterns

215-235 Chase 1 - from left to right, from slow to fast

236-255 Chase 2 - from right to left, from slow to fast

Channel 4 – Dimming curves Dimmer must be open

0-4 Default

5-29 Not functional

30-34 Linear dimming curve

35-39 Square dimming curve

40-44 S-Curve dimming curve

45-49 PL-Curve dimming curve

50-255 Not functional

Channel 5 – Zone 1 - Dimmer intensity Dimmer must be open

0-255 Gradual adjustment, from dark to brightest 0-100%

Channel 6 – Zone 1 - Strobe Duration Dimmer must be open

0-255 Strobe flash duration, from short to long

Channel 7 – Zone 1 - Strobe Dimmer must be open

0-255 Strobe flash frequency, from low to high frequency

Channel 8 – Zone 2 - Dimmer intensity Dimmer must be open

0-255 Gradual adjustment, from dark to brightest 0-100%

Channel 9 – Zone 2 - Strobe Duration Dimmer must be open

0-255 Strobe flash duration, from short to long

Channel 10 – Zone 2 - Strobe Dimmer must be open

0-255 Strobe flash frequency, from low to high frequency

Channel 11 – Zone 3 - Dimmer intensity ⚠️ **Dimmer must be open** ⚠️
0-255 Gradual adjustment, from dark to brightest 0-100%

Channel 12 – Zone 3 - Strobe Duration ⚠️ **Dimmer must be open** ⚠️
0-255 Strobe flash duration, from short to long

Channel 13 – Zone 3 - Strobe ⚠️ **Dimmer must be open** ⚠️
0-255 Strobe flash frequency, from low to high frequency

Channel 14 – Zone 4 - Dimmer intensity ⚠️ **Dimmer must be open** ⚠️
0-255 Gradual adjustment, from dark to brightest 0-100%

Channel 15 – Zone 4 - Strobe Duration ⚠️ **Dimmer must be open** ⚠️
0-255 Strobe flash duration, from short to long

Channel 16 – Zone 4 - Strobe ⚠️ **Dimmer must be open** ⚠️
0-255 Strobe flash frequency, from slow to fast

Channel 17 – Zone 5 - Dimmer intensity ⚠️ **Dimmer must be open** ⚠️
0-255 Gradual adjustment, from dark to brightest 0-100%

Channel 18 – Zone 5 - Strobe Duration ⚠️ **Dimmer must be open** ⚠️
0-255 Strobe flash duration, from short to long

Channel 19 – Zone 5 - Strobe ⚠️ **Dimmer must be open** ⚠️
0-255 Strobe flash frequency, from slow to fast

Channel 20 – Zone 6 - Dimmer intensity ⚠️ **Dimmer must be open** ⚠️
0-255 Gradual adjustment, from dark to brightest 0-100%

Channel 21 – Zone 6 - Strobe Duration ⚠️ **Dimmer must be open** ⚠️
0-255 Strobe flash duration, from short to long

Channel 22 – Zone 6 - Strobe ⚠️ **Dimmer must be open** ⚠️
0-255 Strobe flash frequency, from slow to fast

Channel 23 – Zone 7 - Dimmer intensity ⚠️ **Dimmer must be open** ⚠️
0-255 Gradual adjustment, from dark to brightest 0-100%

Channel 24 – Zone 7 - Strobe Duration ⚠️ **Dimmer must be open** ⚠️
0-255 Strobe flash duration, from short to long

Channel 25 – Zone 7 - Strobe ⚠️ **Dimmer must be open** ⚠️
0-255 Strobe flash frequency, from slow to fast

Channel 26 – Zone 8 - Dimmer intensity ⚠️ **Dimmer must be open** ⚠️
0-255 Gradual adjustment, from dark to brightest 0-100%

Channel 27 – Zone 8 - Strobe Duration ⚠ **Dimmer must be open** ⚠

0-255 Strobe flash duration, from short to long

Channel 28 – Zone 8 - Strobe ⚠ **Dimmer must be open** ⚠

0-255 Strobe flash frequency, from slow to fast

RDM Parameter IDs

The following tables outline and describe all the RDM parameters IDs associated with the XPLO-15 LED Strobe.

XPLO-15 LED Strobe RDM Product Parameter IDs

Model ID	Manufacturer	Model Description	Product Category
0x1109	Infinity(Highlite International)	XPLO-15 LED Strobe	0x0509

XPLO-15 LED Strobe RDM UID

UID					
MSB of ESTA	LSB of ESTA	00H	LSB of Unique Seq.	MSB of Unique Seq.	LSB of Unique Seq.
29H	B4H				

XPLO-15 LED Strobe RDM Parameter IDs

Get Allowed	Set Allowed	RDM Parameter IDs	Value	Comment	Implemented
Category - Network Management					
		DISC_UNIQUE_BRANCH	0x0001		■
		DISC_MUTE	0x0002		■
		DISC_UN_MUTE	0x0003		■
■		PROXIED_DEVICES	0x0010		
■		PROXIED_DEVICES_COUNT	0x0011		
■	■	COMMS_STATUS	0x0015		
Category - Status Collection					
■		QUEUED_MESSAGE	0x0020		■
■		STATUS_MESSAGES	0x0030		■
■		STATUS_ID_DESCRIPTION	0x0031		■
	■	CLEAR_STATUS_ID	0x0032		■
■	■	SUB_DEVICE_STATUS_REPORT_THRESHOLD	0x0033		
Category - RDM Information					
■		SUPPORTED_PARAMETERS	0x0050	Support required only if supporting parameters beyond the minimum required set.	■
■		PARAMETER_DESCRIPTION	0x0051	Support required for Manufacturer-Specific PIDs exposed in SUPPORTED_PARAMETERS message.	■
Category - Product Information					
■		DEVICE_INFO	0x0060		■
■		PRODUCT_DETAIL_ID_LIST	0x0070		
■		DEVICE_MODEL_DESCRIPTION	0x0080		■
■		MANUFACTURER_LABEL	0x0081		■
■	■	DEVICE_LABEL	0x0082		■
■	■	FACTORY_DEFAULTS	0x0090		■
■		LANGUAGE_CAPABILITIES	0x00A0		
■	■	LANGUAGE	0x00B0		
■		SOFTWARE_VERSION_LABEL	0x00C0		■
■		BOOT_SOFTWARE_VERSION_ID	0x00C1		
■		BOOT_SOFTWARE_VERSION_LABEL	0x00C2		
Category - DMX512 Setup					
■	■	DMX_PERSONALITY	0x00E0		■
■		DMX_PERSONALITY_DESCRIPTION	0x00E1		■
■	■	DMX_START_ADDRESS	0x00F0	Required if device uses a DMX Slot	■
■		SLOT_INFO	0x0120		■
■		SLOT_DESCRIPTION	0x0121		■
■		DEFAULT_SLOT_VALUE	0x0122		
Category - Sensors 0x02xx					
■		SENSOR_DEFINITION	0x0200		■
■	■	SENSOR_VALUE	0x0201		■

Get Allowed	Set Allowed	RDM Parameter IDs	Value	Comment	Implemented
	■	RECORD_SENSORS	0x0202		
Category - Dimmer Settings 0x03xx - FUTURE USE					
Category - Power / Lamp Settings 0x04xx					
■	■	DEVICE_HOURS	0x0400		
■	■	LAMP_HOURS	0x0401		
■	■	LAMP_STRIKES	0x0402		
■	■	LAMP_STATE	0x0403		
■	■	LAMP_ON_MODE	0x0404		
■	■	DEVICE_POWER_CYCLES	0x0405		
Category - Display Settings 0x05xx					
■	■	DISPLAY_INVERT	0x0500		■
■	■	DISPLAY_LEVEL	0x0501		
Category - Configuration 0x06xx					
■	■	PAN_INVERT	0x0600		
■	■	TILT_INVERT	0x0601		
■	■	PAN_TILT_SWAP	0x0602		
■	■	REAL_TIME_CLOCK	0x0603		
Category - Control 0x10xx					
■	■	IDENTIFY_DEVICE	0x1000		■
	■	RESET_DEVICE	0x1001		
■	■	POWER_STATE	0x1010		
■	■	PERFORM_SELFTEST	0x1020		
■		SELF_TEST_DESCRIPTION	0x1021		
	■	CAPTURE_PRESET	0x1030		
■	■	PRESET_PLAYBACK	0x1031		

XPLO-15 LED Strobe RDM Manufacturer Status IDs

Manufacturer specific messages are in the range of 0x8000 – 0xFFDF. Each manufacturer specific Status ID shall have a unique meaning which shall be consistent across all products having a given manufacturer ID. See table B-2, ANSI E1.20-2010.

Status ID Message	Value	Data Value 1	Data Value 2	Status ID Description
8100H		00H	00H	ALL OK

XPLO-15 LED Strobe RDM Manufacturer Specific PIDs for Root Device

Get Allowed	Set Allowed	RDM Parameter IDs	Type	Length	Unit	Prefix	Min	Max	Default	Description
Category - Manufacturer Defined PIDs - Range is 0x8000-0xffff (See ANSI E1.20-2010 Standard, Table A-3)										
■	■	8A00H	U8	1	None	None	0	100	100	Dimmer
■	■	8AB2H	U8	1	None	None	1	18	1	Chase
■	■	8AB1H	U8	1	None	None	0	31	0	Preset
■	■	8A92H	U8	1	None	None	0	255	0	Strobe
■	■	8A94H	U8	1	None	None	0	85	0	Duration
■	■	8A40H	S8	1	DB	None	0	1	0	Link Mode
■	■	8AA1H	S8	1	DB	None	0	3	0	Dimming curve
■	■	8A0CH	S8	1	DB	None	0	3	0	DMX Fail Mode
■	■	8AA0H	U8	1	None	None	0	4	0	Backlight OFF Time
■	■	8AA2H	U8	1	None	None	0	50	0	Power-up setup
■	■	8A41H	U8	1	None	None	0	1	0	Lock fixture
■	■	8A98H	U8	1	None	None	0	255	0	Effect

Maintenance

The operator has to make sure that safety-related and machine-technical installations are to be inspected by an expert after every year in the course of an acceptance test.

The operator has to make sure that safety-related and machine-technical installations are to be inspected by a skilled person once a year.

The following points have to be considered during the inspection:

- 01) All screws used for installing the device or parts of the device have to be tightly connected and must not be corroded.
- 02) There may not be any deformations on housings, fixations and installation spots.
- 03) Mechanically moving parts like axles, eyes and others may not show any traces of wearing.
- 04) The electric power supply cables must not show any damages or material fatigue.

The Infinity XPLO-15 LED Strobe requires almost no maintenance. However, you should keep the unit clean. Otherwise, the fixture’s light output will be significantly reduced. Disconnect the mains power supply, and then wipe the cover with a damp cloth. Do not immerse in liquid. Wipe lens clean with glass cleaner and a soft cloth. Do not use alcohol or solvents.

The front lens will require weekly cleaning, as smoke-fluid tends to build up residues, reducing the light-output very quickly.

Please clean internal components once a year with a light brush and vacuum cleaner.

Keep connections clean. Disconnect electric power, and then wipe the DMX and audio connections with a damp cloth. Make sure connections are thoroughly dry before linking equipment or supplying electric power.

Troubleshooting

This troubleshooting guide is meant to help solve simple problems.

If a problem occurs, carry out the steps below in sequence until a solution is found. Once the unit operates properly, do not carry out following steps.

No Light

If the light effect does not operate properly, refer servicing to a technician.

Suspect three potential problem areas as: the power supply and the LEDs.

- 01) Power supply. Check that the unit is plugged into an appropriate power supply.
- 02) The LEDs. Return the Infinity to your Infinity dealer.
- 03) If all of the above appears to be O.K., plug the unit in again.
- 04) If you are unable to determine the cause of the problem, do not open the Power Spot, as this may damage the unit and the warranty will become void.
- 05) Return the device to your Infinity dealer.

No Response to DMX

Suspect the DMX cable or connectors, a controller malfunction, a light effect DMX card malfunction.

- 01) Check the DMX setting. Make sure that DMX addresses are correct.
- 02) Check the DMX cable: Unplug the unit; change the DMX cable; then reconnect to electrical power. Try your DMX control again.
- 03) Determine whether the controller or light effect is at fault. Does the controller operate properly with other DMX products? If not, take the controller in for repair. If so, take the DMX cable and the light effect to a qualified technician.

Problem	Probable cause(s)	Solution
One or more fixtures do not function at all	No power to the fixture	<ul style="list-style-type: none"> Check if power is switched on and cables are plugged in
	Internal fuse blown	<ul style="list-style-type: none"> Return the device to your local dealer.
Fixtures reset correctly, but all respond erratically or not at all to the controller	The controller is not connected.	<ul style="list-style-type: none"> Connect controller.
	3-pin XLR Out of the controller does not match XLR Out of the first fixture on the link (i.e. signal is reversed)	<ul style="list-style-type: none"> Install a phase reversing cable between the controller and the first fixture on the link
Fixtures reset correctly, but some respond erratically or not at all to the controller	Poor data quality	<ul style="list-style-type: none"> Check data quality. If much lower than 100 percent, the problem may be a bad data link connection, poor quality or broken cables, missing termination plug, or a defective fixture disturbing the link
	Bad data link connection	<ul style="list-style-type: none"> Inspect connections and cables. Correct poor connections. Repair or replace damaged cables
	Data link not terminated with 120 Ohm termination plug	<ul style="list-style-type: none"> Insert termination plug in output jack of the last fixture on the link
	Incorrect addressing of the fixtures	<ul style="list-style-type: none"> Check address setting
	One of the fixtures is defective and disturbs data transmission on the link	<ul style="list-style-type: none"> Bypass one fixture at a time until normal operation is restored: unplug both connectors and connect them directly together. Have the defective fixture serviced by a qualified technician
	3-pin XLR Out on the fixtures does not match (pins 2 and 3 reversed)	<ul style="list-style-type: none"> Install a phase-reversing cable between the fixtures or swap pin 2 and 3 in the fixture that behaves erratically
No light or lamp cuts out intermittently	Fixture is too hot	<ul style="list-style-type: none"> Allow the fixture to cool down Make sure air vents in control panel and the front lens are not blocked Turn up the air conditioning
	LEDs damaged	<ul style="list-style-type: none"> Disconnect the fixture and return it to your dealer
	The power supply settings do not match local AC voltage and frequency	<ul style="list-style-type: none"> Disconnect fixture. Check settings and correct if necessary

Product Specifications

Model:	Infinity XPLO-15 LED Strobe
Input Voltage:	100-240 VAC, 60/50Hz
Power consumption:	132W (full output)
DMX linking:	30pcs
Dimensions:	319 x 130 x 255 mm (LxWxH)
Weight:	5,4 kg
Operating and Programming:	
Signal pin OUT:	Pin 1 (earth), pin 2 (-), pin 3 (+)
DMX Mode:	1, 3, 4, 6, 28 Channels
Signal input:	3-pin DMX/RDM IN
Signal output:	3-pin DMX/RDM OUT
Electro-mechanical effects:	
Light Source:	576 x 6500K Luxeon SMD
Output:	28000 lux
Color mixing:	White
Color temperature:	6500K
Beam angle:	115°
Dimmer:	0-100%
Strobe:	0,5-30Hz
Dimming Curves:	Dimming curves: Linear, PL-Curve, S-Curve, Square-Curve
Housing:	Metal & Flame retardant plastic
IP rating:	IP54
DMX-control:	via standard DMX/RDM controller
On Board:	LCD display with gravity sensor
Control:	Stand-alone, Master/Slave, DMX
Connections:	Dedicated Schuko to Neutrik True1 & Data connector
Max. ambient temperature t_a :	40°C
Max. housing temperature t_B :	80°C
Minimum distance:	
Minimum distance from flammable surfaces:	0,5 m
Minimum distance to lighted object:	1 m

Design and product specifications are subject to change without prior notice.



Website: www.Showtec.info

Email: service@highlite.nl

Dimensions

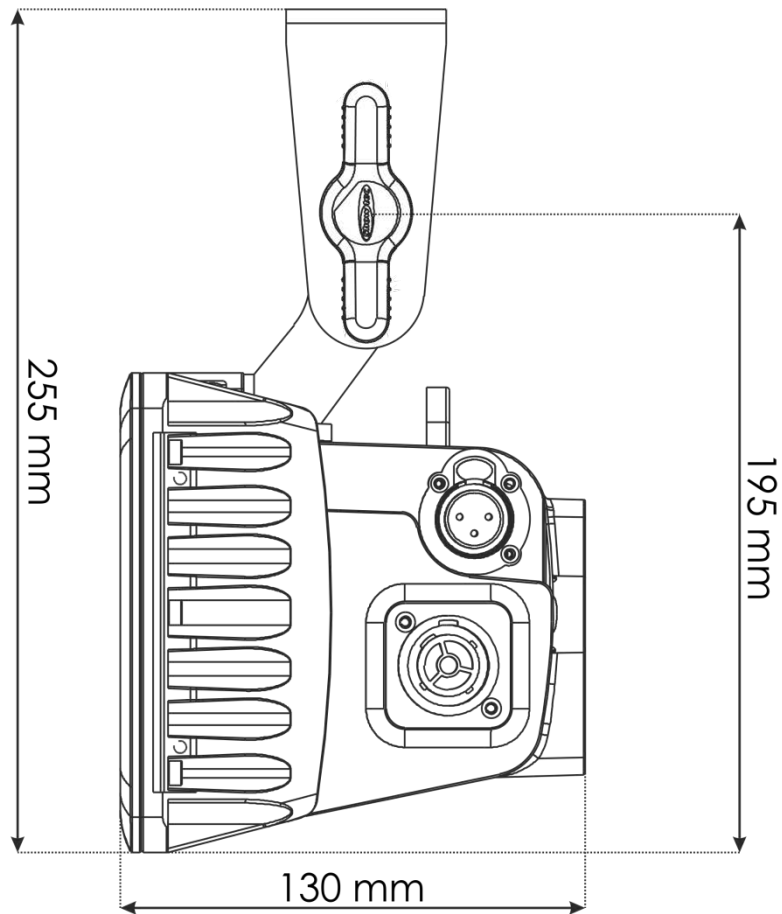
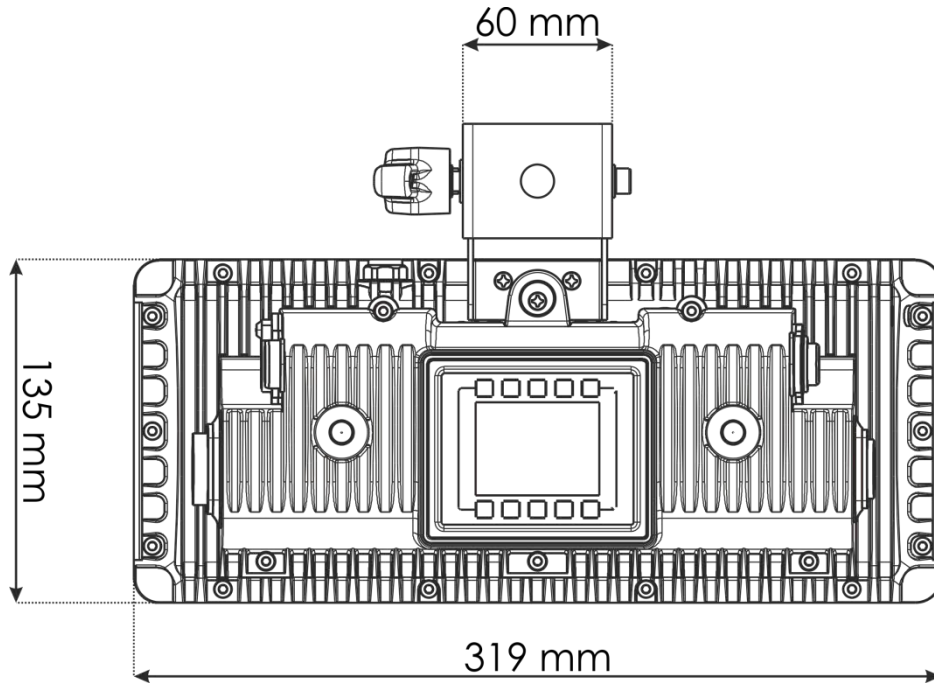



©2015 Infinity